

HL6312G/13G

AlGaInP Laser Diodes

HITACHI

ADE-208-190G (Z)
8th Edition
Dec. 2000

Description

The HL6312G/13G are 0.63 μm band AlGaInP laser diodes with a multi-quantum well (MQW) structure. Wavelength is equal to He-Ne Gas laser. They are suitable as light sources in bar code readers, laser levelers and various other types of optical equipment. Hermetic sealing of the package achieves high reliability.

Features

- Visible light output: $\lambda_p = 635 \text{ nm}$ Typ (nearly equal to He-Ne Gas Laser)
- Optical output power: 5 mW CW
- Low Operating voltage: 2.7 V Max
- Single longitudinal mode
- Built-in photodiode for monitoring laser output
- TM mode oscillation

Package Type
• HL6312G/13G: G2

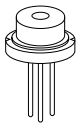

Internal Circuit
• HL6312G

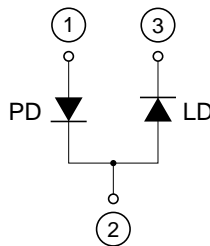

Internal Circuit
• HL6313G

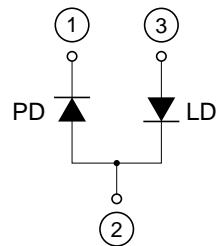

Absolute Maximum Ratings ($T_C = 25^\circ\text{C}$)

Item	Symbol	Rated Value	Unit
Optical output power	P_O	5	mW
Pulse optical output power	$P_{O(\text{pulse})}$	6 *	mW
LD reverse voltage	$V_{R(\text{LD})}$	2	V
PD reverse voltage	$V_{R(\text{PD})}$	30	V
Operating temperature	T_{opr}	-10 to +50	$^\circ\text{C}$
Storage temperature	T_{stg}	-40 to +85	$^\circ\text{C}$

Note: Pulse condition : Pulse width $\leq 1 \mu\text{s}$, duty $\leq 50\%$

Optical and Electrical Characteristics ($T_C = 25^\circ\text{C}$)

Item	Symbol	Min	Typ	Max	Unit	Test Conditions
Optical output power	P_O	5	—	—	mW	Kink free
Threshold current	I_{th}	20	45	70	mA	
Operating current	I_{OP}	—	55	85	mA	$P_O = 5 \text{ mW}$
Operating voltage	V_{OP}	—	—	2.7	V	$P_O = 5 \text{ mW}$
Beam divergence parallel to the junction	$\theta_{//}$	5	8	11	deg.	$P_O = 5 \text{ mW}$
Beam divergence perpendicular to the junction	θ_{\perp}	25	31	37	deg.	$P_O = 5 \text{ mW}$
Astigmatism	A_s	—	8	—	μm	$P_O = 5 \text{ mW}$, $\text{NA} = 0.55$
Lasing wavelength	λ_p	625	635	640	nm	$P_O = 5 \text{ mW}$
Monitor current	I_s	0.2	0.4	0.8	mA	$P_O = 5 \text{ mW}$, $V_{R(\text{PD})} = 5 \text{ V}$

Typical Characteristic Curves

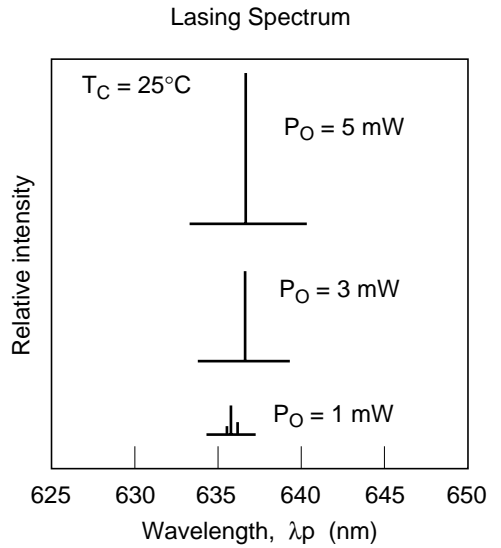
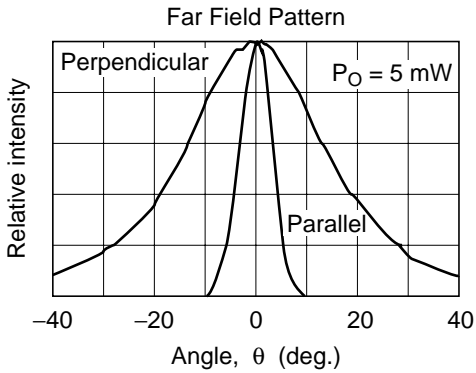
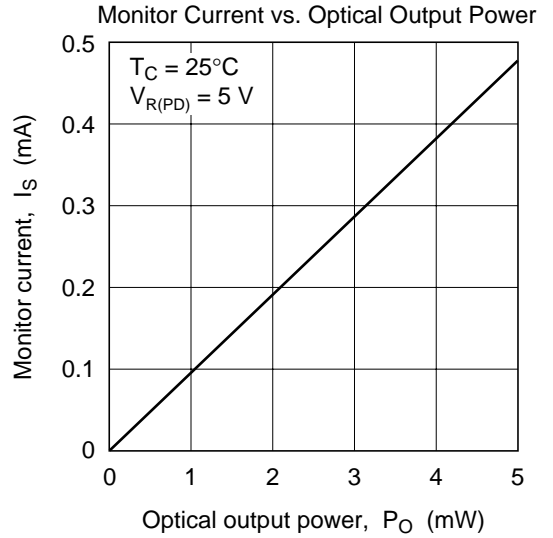
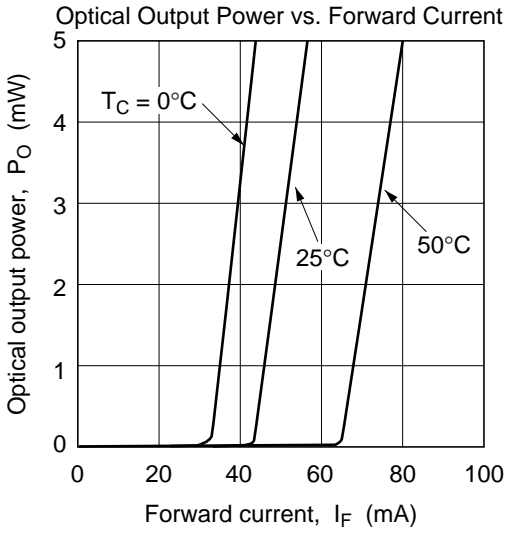

Typical Characteristic Curves (cont)

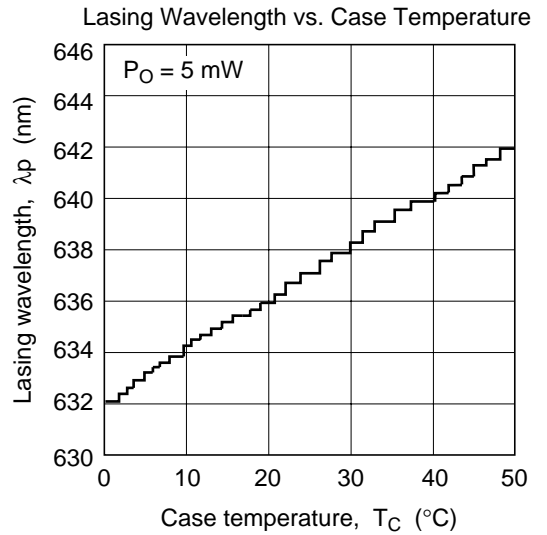
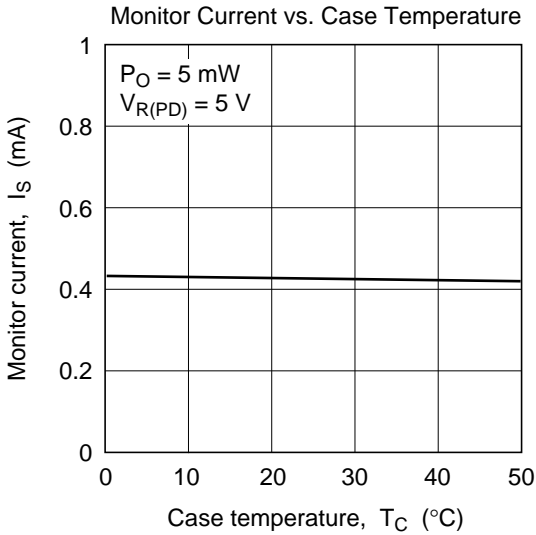
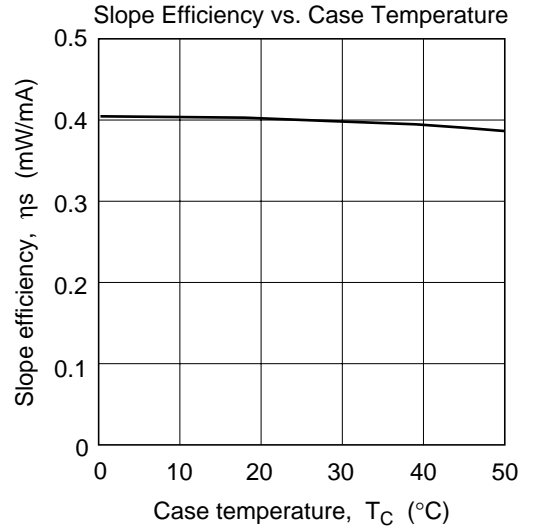
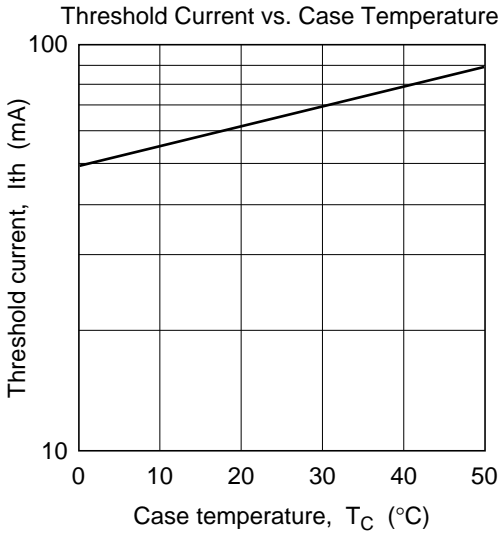

Typical Characteristic Curves (cont)

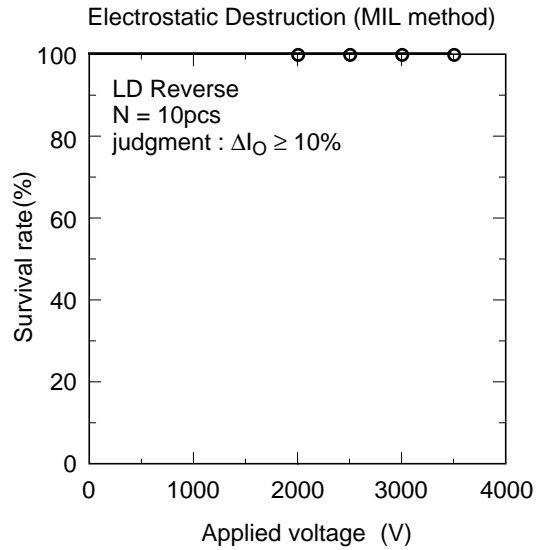
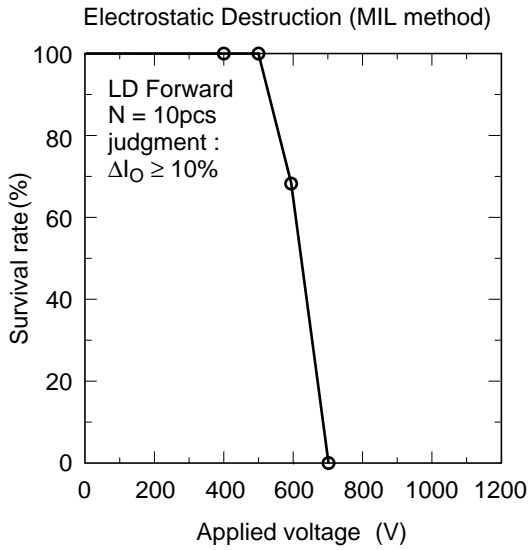
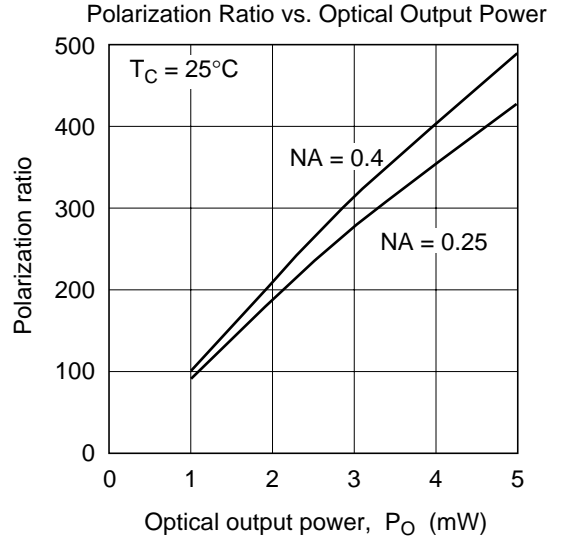
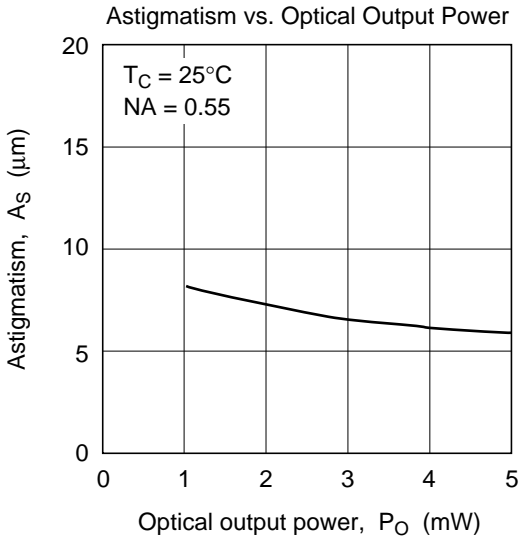

Package Dimensions

Unit: mm

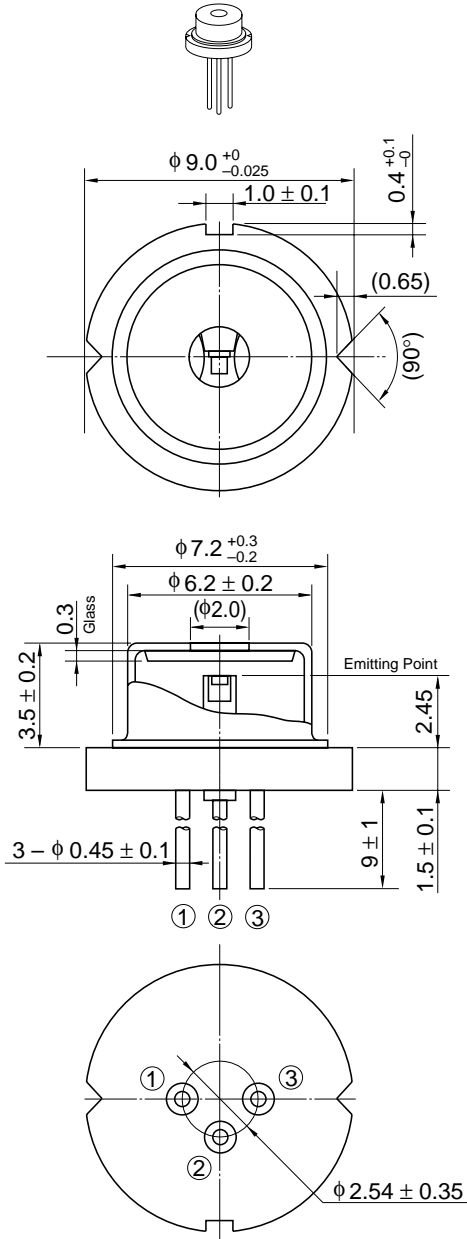

Hitachi Code	LD/G2
JEDEC	—
EIAJ	—
Mass (reference value)	1.1 g

Cautions

1. Hitachi neither warrants nor grants licenses of any rights of Hitachi's or any third party's patent, copyright, trademark, or other intellectual property rights for information contained in this document. Hitachi bears no responsibility for problems that may arise with third party's rights, including intellectual property rights, in connection with use of the information contained in this document.
2. Products and product specifications may be subject to change without notice. Confirm that you have received the latest product standards or specifications before final design, purchase or use.
3. Hitachi makes every attempt to ensure that its products are of high quality and reliability. However, contact Hitachi's sales office before using the product in an application that demands especially high quality and reliability or where its failure or malfunction may directly threaten human life or cause risk of bodily injury, such as aerospace, aeronautics, nuclear power, combustion control, transportation, traffic, safety equipment or medical equipment for life support.
4. Design your application so that the product is used within the ranges guaranteed by Hitachi particularly for maximum rating, operating supply voltage range, heat radiation characteristics, installation conditions and other characteristics. Hitachi bears no responsibility for failure or damage when used beyond the guaranteed ranges. Even within the guaranteed ranges, consider normally foreseeable failure rates or failure modes in semiconductor devices and employ systemic measures such as fail-safes, so that the equipment incorporating Hitachi product does not cause bodily injury, fire or other consequential damage due to operation of the Hitachi product.
5. This product is not designed to be radiation resistant.
6. No one is permitted to reproduce or duplicate, in any form, the whole or part of this document without written approval from Hitachi.
7. Contact Hitachi's sales office for any questions regarding this document or Hitachi semiconductor products.

1. The laser light is harmful to human body especially to eye no matter what directly or indirectly. The laser beam shall be observed or adjusted through infrared camera or equivalent.

HITACHI

Hitachi, Ltd.

Semiconductor & Integrated Circuits.

Nippon Bldg., 2-6-2, Ohte-machi, Chiyoda-ku, Tokyo 100-0004, Japan

Tel: Tokyo (03) 3270-2111 Fax: (03) 3270-5109

URL NorthAmerica : <http://semiconductor.hitachi.com/>
 Europe : <http://www.hitachi-eu.com/hel/ecg>
 Asia : <http://sicapac.hitachi-asia.com>
 Japan : <http://www.hitachi.co.jp/Sicd/indx.htm>

For further information write to:

Hitachi Semiconductor
(America) Inc.
179 East Tasman Drive,
San Jose, CA 95134
Tel: <1> (408) 433-1990
Fax: <1> (408) 433-0223

Hitachi Europe GmbH
Electronic Components Group
Dornacher Straße 3
D-85622 Feldkirchen, Munich
Germany
Tel: <49> (89) 9 9180-0
Fax: <49> (89) 9 29 30 00

Hitachi Europe Ltd.
Electronic Components Group.
Whitebrook Park
Lower Cookham Road
Maidenhead
Berkshire SL6 8YA, United Kingdom
Tel: <44> (1628) 585000
Fax: <44> (1628) 585160

Hitachi Asia Ltd.
Hitachi Tower
16 Collyer Quay #20-00,
Singapore 049318
Tel: <65>-538-6533/538-8577
Fax: <65>-538-6933/538-3877
URL: <http://www.hitachi.com.sg>

Hitachi Asia Ltd.
(Taipei Branch Office)
4/F, No. 167, Tun Hwa North Road,
Hung-Kuo Building,
Taipei (105), Taiwan
Tel: <886>-(2)-2718-3666
Fax: <886>-(2)-2718-8180
Telex: 23222 HAS-TP
URL: <http://www.hitachi.com.tw>

Hitachi Asia (Hong Kong) Ltd.
Group III (Electronic Components)
7/F., North Tower,
World Finance Centre,
Harbour City, Canton Road
Tsim Sha Tsui, Kowloon,
Hong Kong
Tel: <852>-(2)-735-9218
Fax: <852>-(2)-730-0281
URL: <http://www.hitachi.com.hk>

Copyright © Hitachi, Ltd., 2000. All rights reserved. Printed in Japan.
Colophon 2.0

HITACHI